

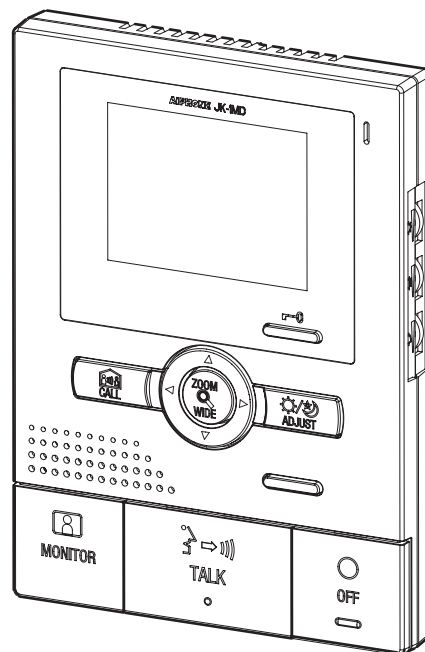

JK-1MD

HANDS FREE COLOR VIDEO INTERCOM
 MASTER MONITOR STATION
 INTERPHONE VIDEO COULEUR MAINS LIBRES
 MONITEUR MAÎTRE
 VIDEO INTERCOMUNICADOR A COLOR MANOS LIBRES
 APARATO PRINCIPAL CON MONITOR
 HANDENVRIJE KLEURENVIDEOFONIE
 MONITOR-HOOFDPOST
 VIDEOCITOFONO A COLORI A VIVAVOCE
 POSTAZIONE DI MONITORAGGIO PRINCIPALE



JK-1MD

Master monitor station
 Moniteur maître
 Aparato principal con monitor
 Monitor-hoofdpost
 Postazione di monitoraggio
 principale

INSTALLATION & OPERATION MANUAL
 MANUEL D'INSTALLATION ET D'UTILISATION
 MANUAL DE INSTALACIÓN Y OPERACIÓN
 INSTALLATIE- EN GEBRUIKSHANDLEIDING
 MANUALE D'INSTALLAZIONE E USO

PRECAUTIONS

- ⊘ General Prohibitions
 ⊘ Prohibition to Dismantle the Unit
 ⊘ Prohibition on Subjecting the Unit to Water
 ! General Precautions

⚠ WARNING

(Negligence could result in death or serious injury.)

- ⊘ 1. High voltage is present internally. Do not open the case. Electric shock could result.
- ⊘ 2. Do not dismantle or alter the unit. Fire or electric shock could result.
- ⊘ 3. Do not connect a non-specified power source to the +, - terminals. Also, do not install two power supplies in parallel to a single input. Fire or damage to the unit could result.
- ⊘ 4. Keep the unit away from water or any other liquid. Fire or electric shock could result.
- ⊘ 5. Do not put any metal or flammable material into the unit through the openings. Fire or electric shock could result.
- ⊘ 6. Do not use a power supply with a voltage other than the specified voltage. Fire or electric shock could result.
- ⊘ 7. Do not connect any terminal on the unit to an AC power line. Fire or electric shock could result.

⚠ CAUTION

(Negligence could result in injury to people or damage to property.)

- ⊘ 1. Do not install or make any wire terminations while power supply is plugged in. It can cause electrical shock or damage to the unit.
- ! 2. Before turning on power, make sure wires are not crossed or shorted. If not, fire or electric shock could result.
- ! 3. When mounting the unit on a wall, install the unit in a convenient location, but not where it could be jarred or bumped. Injury could result.
- ! 4. For power supply, use Aiphone power supply model or model specified for use with system. If non-specified product is used, fire or malfunction could result.
- ⊘ 5. Do not install the unit in any of the following locations. Fire, electric shock, or unit trouble could result.
 - * Places under direct sunlight or places near heating equipment that varies in temperature.
 - * Places subject to dust, oil, chemicals, etc.
 - * Places subject to moisture and humidity extremes, such as bathrooms, cellars, greenhouses, etc.
 - * Places where the temperature is quite low, such as inside a refrigerated area or in front of an air conditioner.
 - * Places subject to steam or smoke (near heating or cooking surfaces).
 - * Where noise generating devices such as dimmer switches or inverter electrical appliances are close by.
 - * Do not install the unit in locations subject to frequent vibration or impact.
- ⊘ 6. Do not put anything on the unit or cover the unit with cloth, etc. Fire or unit trouble could result.
- ⊘ 7. Do not press on the LCD or subject it to a high impact. The LCD glass could be punctured and result in an injury.
- ⊘ 8. If the LCD is punctured, do not allow contact with the liquid crystal inside. Inflammation could result.
 - * In the event that liquid crystal enters your mouth, immediately gargle with water and seek medical attention.
 - * If contact with the eyes or skin occurs, clean with pure water for at least 15 minutes and seek medical attention.

General Precautions

1. Keep the unit more than 1 m away from radio or TV set.
2. This unit is for indoor use only. Do not use outdoors.
3. In areas where broadcasting station antennas are close by, the intercom system may be affected by radio frequency interference.
4. As to other manufacturer's devices (such as sensor, detectors, door releases) used with this system, comply with the Specifications and Warranty conditions that the manufacturers or vendors present.
5. Keep the intercom wires at least 30 cm (12") away from AC 100-240 V lines. Noise and malfunction could result.
6. If the unit is down or does not operate properly, unplug the power supply or turn off the JK-1MD and JK1-1HD (JK-1SD) POWER switches.
7. The unit is for wall-mount use only. For desktop applications, use desk stand.
8. When wall-mounted, the top of the unit may darken. This does not indicate a malfunction.
9. The unit case may become warm with use, but this is not a unit malfunction.
10. If a cellular phone is used close by, the unit may malfunction.
11. The LCD panel is manufactured with very high precision techniques. Small portions of the panel may fail to light up or some portions may be constantly lit, but this does not indicate a unit malfunction. Please be aware of this in advance.
12. Refrain from using the color monitor station in sunlight areas.
13. At night, due to reduced lighting on the object, the monitor sees more noise and the face becomes more difficult to see, but this is not malfunction.
14. Talk within 50 cm (20") or less from the unit. If you stand too far away, it may be difficult for the other person to hear the communication.
15. If there are loud noises around the unit (such as music playing or children crying), the sound may break up and be difficult to hear.
16. During communication, if you speak before the other person has finished talking, your voice may not be heard. Communication will proceed smoothly if you wait until the other person has finished before speaking.
17. At a gate or porch illuminated by fluorescent lamp, the picture may vary, but this is not a malfunction.
18. When the outside temperature lowers sharply after rainfall, etc., the inside of the video door station may fog up slightly and cause the video image to be blurry, but this is not a malfunction. Normal operation will be restored when moisture evaporates.
19. Due to the environmental sound around the unit, it may hinder smooth communication, but this is not a malfunction.
20. The outline of video images displayed by video door station may differ from that of the actual person(s) or background, but this is not a malfunction.
21. If the screen of a video door station freezes during wintertime, the picture may become difficult to see or the CALL button may not move, but this is not a malfunction.
22. This unit is not interchangeable with JA, JF, KB, and KC series units.
23. Warm-color lighting shining on the door station may change the tint of the picture on the monitor.

1 PACKAGE CONTENTS

JK-1MD

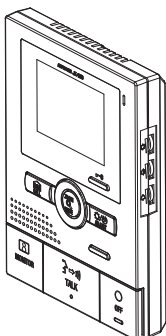

Mounting screws x 2



Wood mounting screws x 2



Option connector



Installation & Operation manual

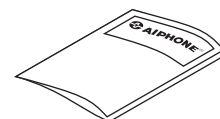

2 INSTALLATION

2-1 Mounting locations

- 1 Install the master monitor station in a place where the screen is not exposed to direct sunlight.
- 2 The master monitor station has switches on both sides. Allow at least 5 cm (2") of open space on either side.
- 3 Allow 15 cm (6") or more of vertical open space from the center of the mounting bracket in order to mount the master monitor station.

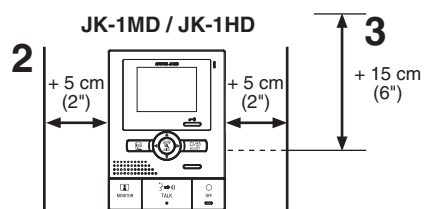
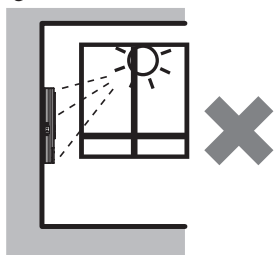

2-2 Wiring method, wiring distance

Wire the units from station-to-station (daisy-chained).

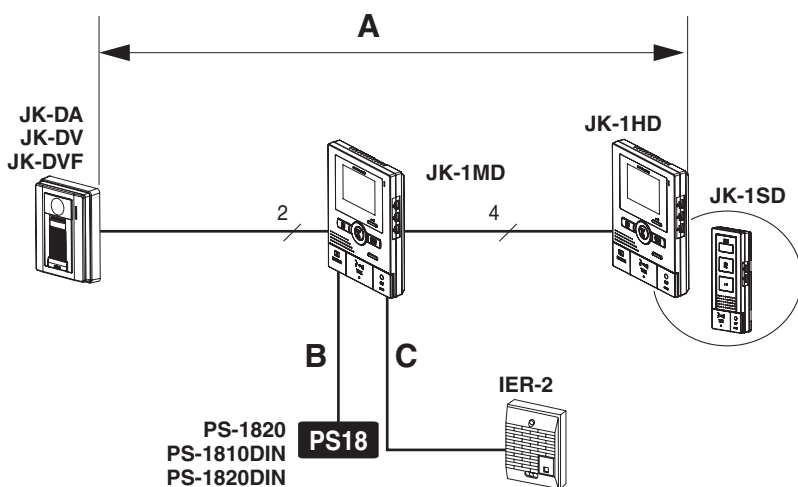

	Ø 0.65 mm	22 AWG	Ø 1.0 mm	18 AWG
A	50 m	165'	100 m	330'
B	5 m	16'	10 m	33'
C	75 m	245'	150 m	490'

2-3 Cable

- 1 Use PVC-coated cable with PE (polyethylene) insulation.
- 2 Never use individual conductors, twisted pair cable or coaxial cable.
- 3 When using a cable with unused conductors, terminate both ends of the unused pair(s) with a 120 Ω resistor.



- 2 Never use individual conductors, twisted pair cable or coaxial cable.

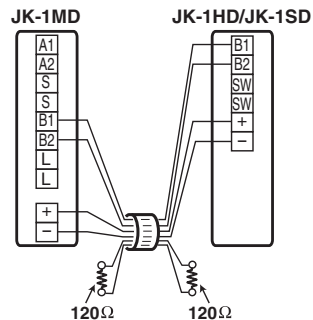
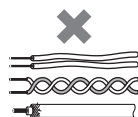

3 MOUNTING

Back wiring

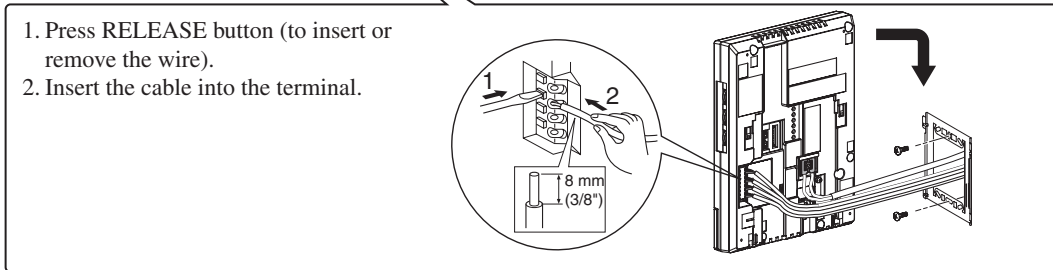
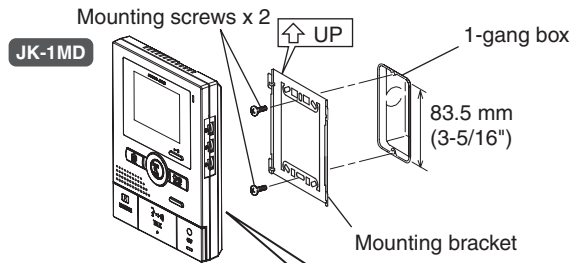

Surface wiring

* When a 1-gang box is not mounted, the cable can be routed as surface wiring to the top or bottom of the unit. Cut a cable inlet on the upper part of the unit to allow passage of the wiring into the unit.

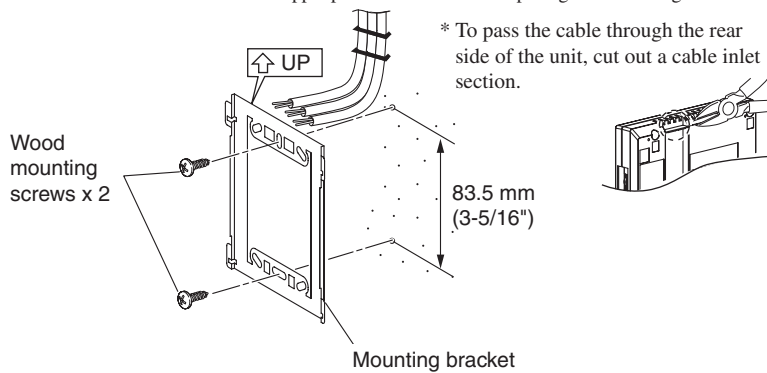

PS-1820

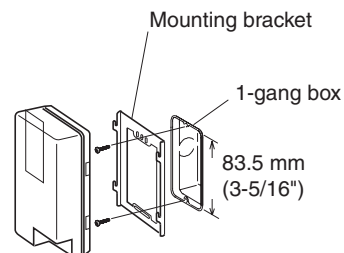

PS-1810DIN/ PS-1820DIN

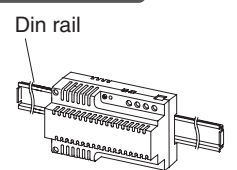

Option connector: Control external devices connected with the option connector.

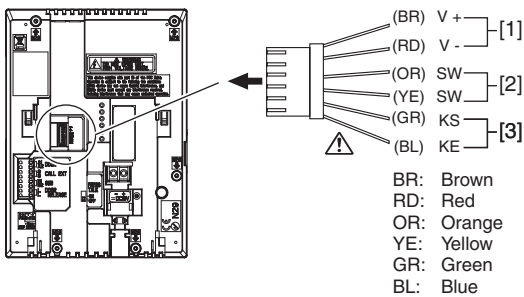

Press-to-talk setting: Press-to-talk can be set to be enabled or disabled.

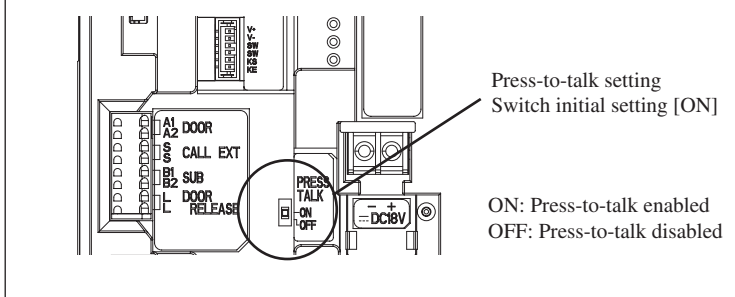

⚠ To prevent shorts, be sure to cut unused lead wires at the bottom and insulate the ends.

[1]Video signal output: Video can be output to DVR, etc. (NTSC, 1 Vp-p/75 Ω) Wiring distance: 3 m (10')
NOTES:When a video signal is output, the monitor station may produce a buzzing sound depending on the installation environment.
A video signal is only output during calling from a door station to the JK-1MD/during communication between a door station and the JK-1MD/during monitoring from the JK-1MD (screen playing recorded pictures is not output).

[2]Options output (AC/DC 24 V, 1.6 A N/O dry closure contact) (Minimum contact: 100 mV DC, 0.1 mA)

[3]External sensor input
External sensor input specifications

Input method	N/O dry closure contact External sensor input (start signal only detection method)
Detection confirmation time	100 mS or more
Contact resistance	During dry closure: Less than 700 Ω During N/C dry closure: At least 3 k Ω
Terminal short current	Less than 10 mA
Voltage between terminals	Less than DC 20 V (when open between terminals)

4 WIRING

Insert wires securely into each terminal as shown.

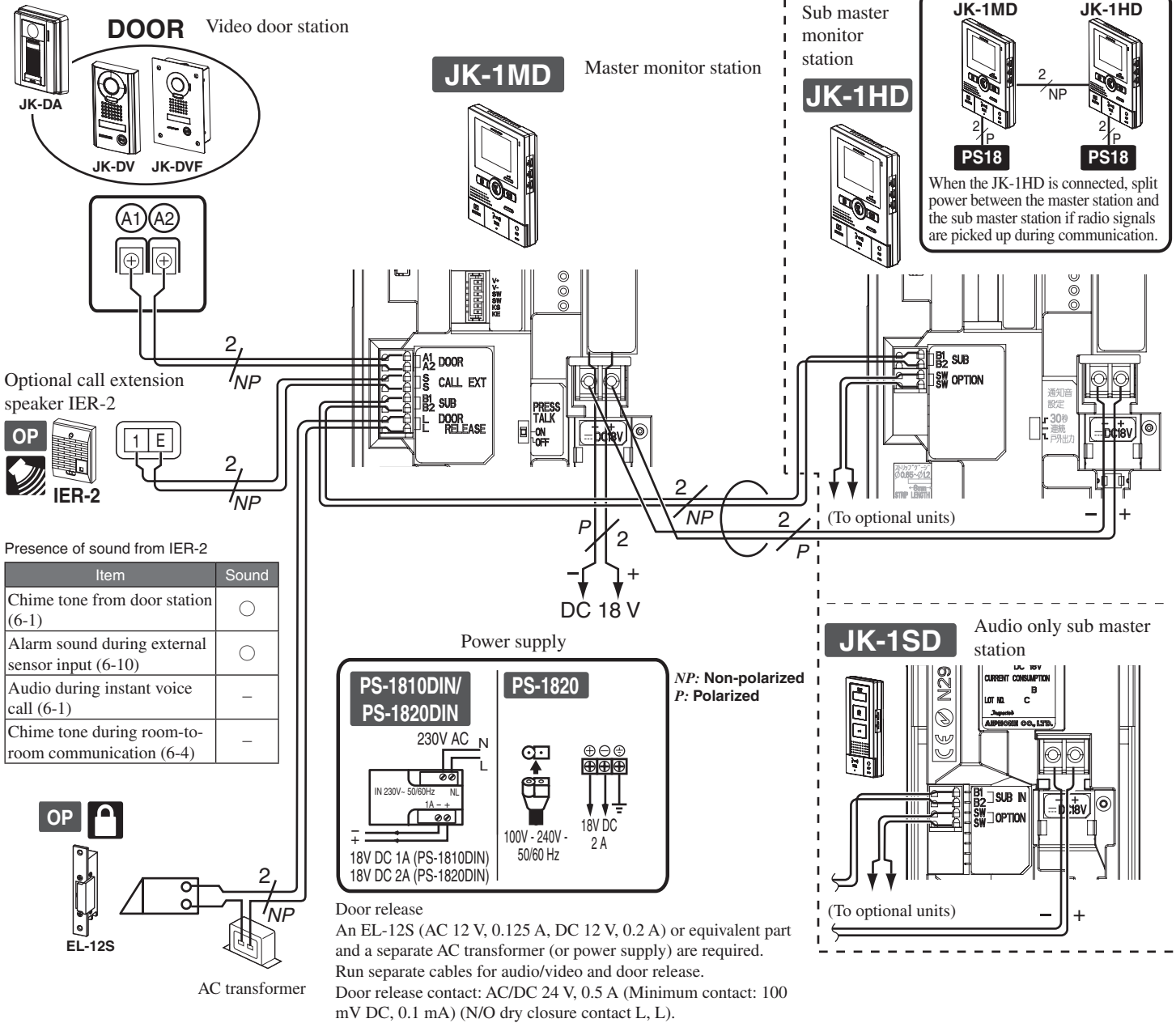

Optional long distance adaptor JKW-BA

Use the long distance adaptor JKW-BA within the distance ranges shown in the table when the wiring distance between the door station and the furthest inside unit is longer than the distance in 2-2 on p. 3.

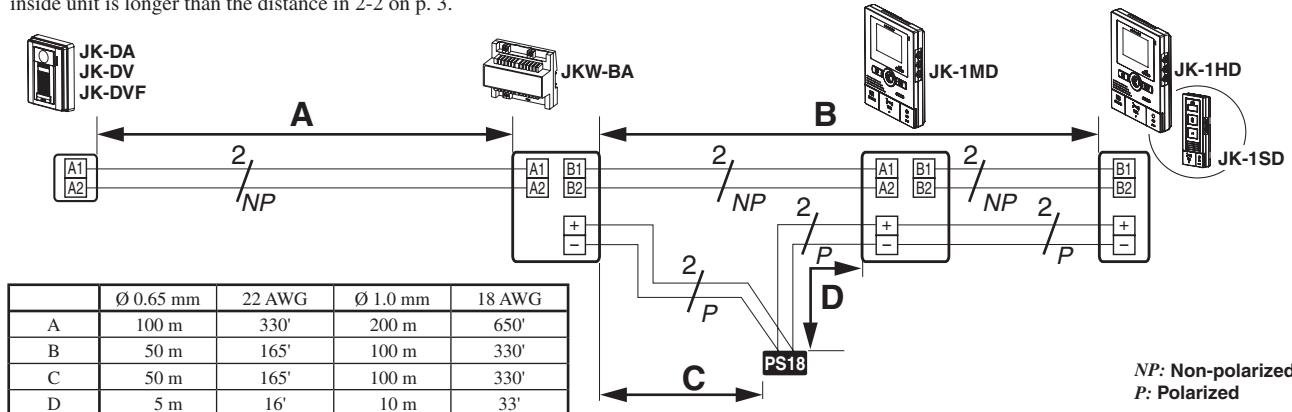

5 NAMES

English

Français

Español

Nederlands

Italiano

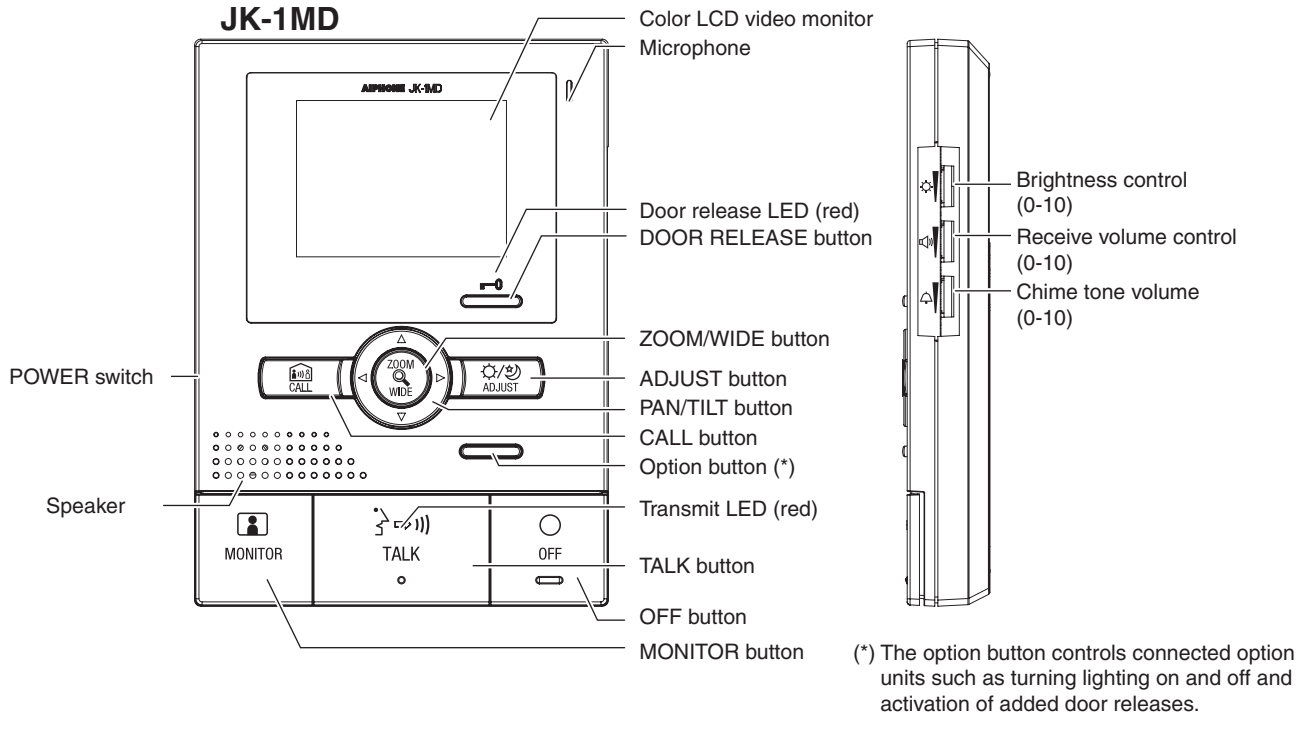

6 OPERATIONS

6-1 Answering a door call (HANDS-FREE mode, PTT mode)

- 1 Press CALL button.



- 2 Chime tone sounds, caller is seen on video monitor, and outside sound is heard.

- Audio and video turns off after approx. 45 seconds if not answered.



- 3 Press $\frac{1}{2}$ TALK button momentarily, and after the beep, communicate hands free. Transmit LED (red) lights when you talk, and goes off as you listen to caller (or hear outside sounds).

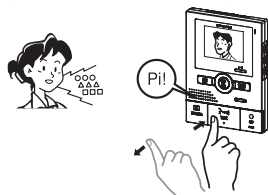

- 4 After finishing communication, pressing OFF button and communication will end after the beep.

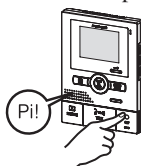

NOTES: 1. Communication (video) ends automatically after approx. 1 minute.
2. The transmit LED will light up and go out, but this is not a malfunction.

Instant voice call function

- 2 Even without answering, door area can be seen and heard with video and audio (for approx. 45 seconds). Inside sound is not heard outside.

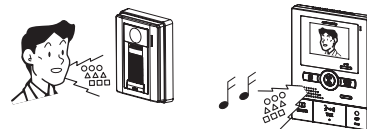

PTT mode

- 3 Press and hold the $\frac{1}{2}$ TALK button for 1 second or more. A beep sounds, and after approx. 1 second another beep sounds, PTT mode is engaged. If $\frac{1}{2}$ TALK button is pressed briefly (less than 0.5 seconds), press-to-talk mode is not engaged.



- 4 When communicating, keep $\frac{1}{2}$ TALK button pressed. To hear the caller's voice, release $\frac{1}{2}$ TALK button.

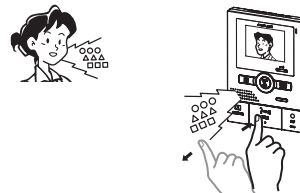

- 5 After finishing communication, pressing OFF button and communication will end after the beep.

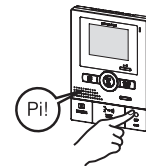

NOTES: When press-to-talk is disabled, PTT mode cannot be used.

6-2 Activating door release

- 1 Press \rightarrow DOOR RELEASE button.

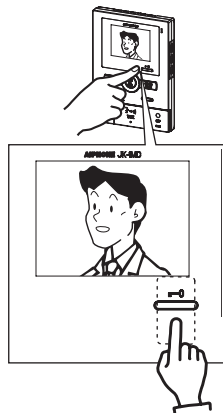

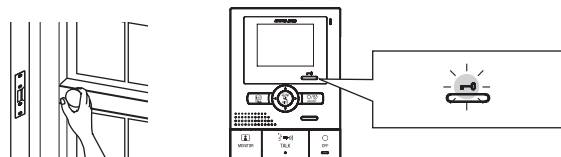

- 2 Open door while the release mechanism is activated. During release: The DOOR RELEASE LED (red) flashes.

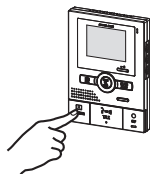

6-3 Entrance monitoring

- 1 Press  MONITOR button in the standby mode.







- 2 The video monitor displays the image from the door station and the incoming audio is heard. If you do not press  TALK button, the caller will not hear sounds from the inside station.



- 3 Press  OFF button to end communication.





NOTES: 1. To talk to the entrance during entrance monitoring, momentarily press  TALK button. This allows communication with the entrance.
 2. The entrance monitoring turns off automatically after approx. 1 minute. To monitor the entrance again, repeat from the beginning.
 3. During entrance monitoring, the monitoring time can be extended by approx. 1 min. by pressing  MONITOR button.
 4. During entrance monitoring, the wide picture display is used. Press  ZOOM/WIDE button to switch to the zoom picture.
 5. At night, the Illuminator LED will not light up until  TALK button is pressed.
 6. If another inside unit attempts to perform entrance monitoring while one inside unit is already doing so, a warning beep sound will occur.

6-4 Room-to-room communication

- 1 Press  CALL button to talk with the other person.

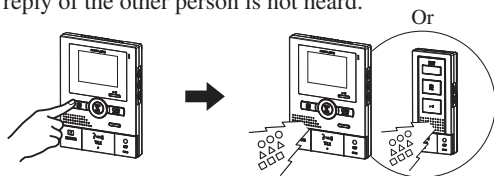
- A call-in is sent to the sub station.
- The reply of the other person is not heard.



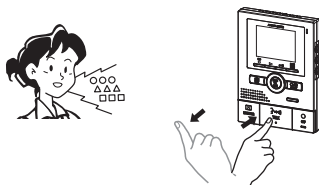

- 2 If the other person presses  TALK button, hands free communication is possible.



- 3 Press and release  OFF button to end communication.



NOTES: 1. Room-to-room communication ends automatically after approx. 10 minutes.
 To perform room-to-room communication again, repeat from the beginning.
 2. If a call is received from the entrance during room-to-room communication, the image from the entrance is displayed at the monitor station and sub station where communication is taking place. Press  OFF button to end the room-to-room communication, and press  TALK button to switch to communication with the door station.

6-5 Wide/Zoom switching

- 1 Press  ZOOM/WIDE button when a picture is displayed.

Switching between wide \leftrightarrow zoom occurs each time the button is pressed.

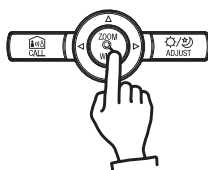

[Wide picture]



[Zoom picture]

NOTES: 1. When the caller is not shown in the center of the picture, the zoom picture can be moved up, down, left, and right. (Refer to section 6-6)
 When switching from the wide picture to the zoom picture, the zoom picture starts at the pre-set (section 6-7) position.

 The wide picture may be distorted in comparison with the zoom picture due to the characteristics of the door station camera, but this is not a malfunction.

6-6 Pan/Tilt operation

1 When a zoom picture is displayed, press the [▲] [▼] [◀] and [▶] buttons.

- [▲] : Up
- [▼] : Down
- [◀] : Left
- [▶] : Right
- Moving diagonally is also possible.

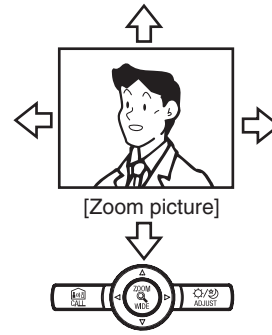
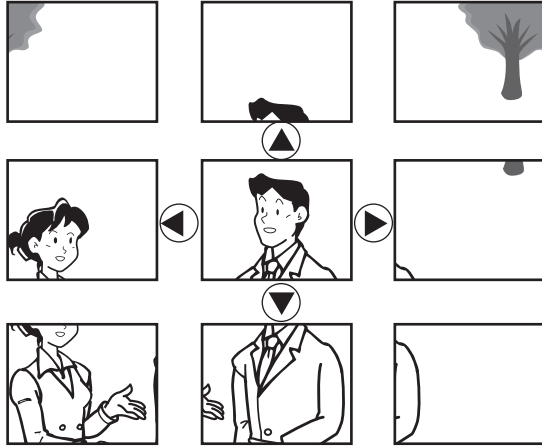

⚠ The image range of the zoom picture and wide picture differs. The edges of the wide picture do not display with the zoom picture.

6-7 Zoom Picture Preset

The picture can be set to display using a set zoom picture position for when a call is received from the door station. When switching from the wide picture to the zoom picture, the zoom picture displays at the pre-set position.

1 When a zoom picture is displayed, press the [▲] [▼] [◀] and [▶] buttons.

- While viewing the picture, set the desired picture position.

2 Press  ZOOM/WIDE button (for 2 seconds to more).

- A beep will sound and the position setting will be completed.

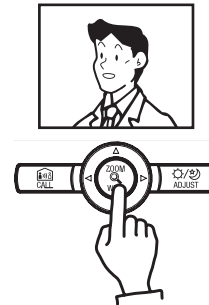

NOTES: 1. To change the zoom picture position that has been set, perform the zoom position setting again. The previous setting will be overwritten.
2. The zoom picture position set with the monitor station will be reflected with the sub monitor station. ※ Pre-setting cannot be done from the sub monitor station (JK-1HD).

6-8 Night illumination

At night, the door station Illuminator LED lights up during calling or communication.

6-8-1 When a call is made from the doorstation

1 If CALL button of door station is pressed

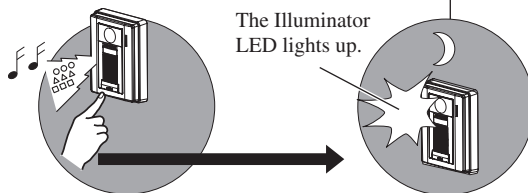

2 When communication ends, the illuminator LED will go out.

6-8-2 When the Illuminator LED is lit up during entrance monitoring

1 When  TALK button is pressed during entrance monitoring, communication starts and the Illuminator LED will light up.

- Inside sound can be heard at the entrance.

⚠ Communication starts at this time, so be aware that inside sound can be heard at the entrance.

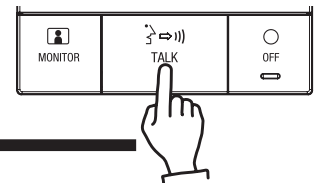

2 When communication ends, the illuminator LED will go out.

NOTES: Distinguishing between day and night is automatically done by the door station.

6-9 Backlight adjustment, Night sensitivity adjustment

To perform adjustment

- 1 Press  ADJUST button when the screen is difficult to see.
 - Automatic adjustment to a more visible screen is performed.

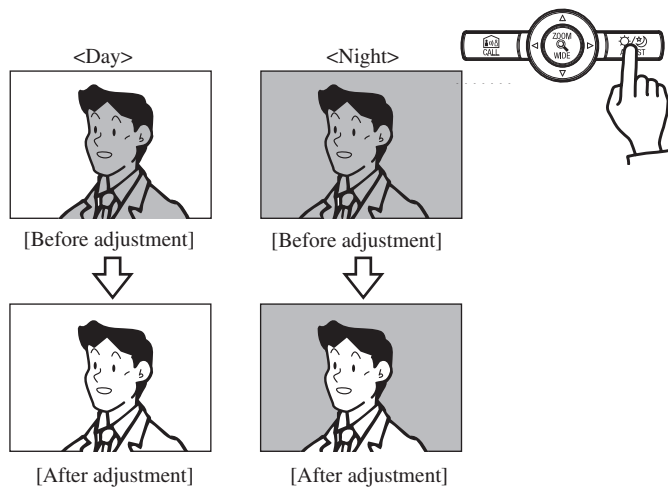

To halt adjustment

- 1 Press  ADJUST button during adjustment.

NOTES: 1. Distinguishing between day and night is automatically done by the door station.
2. Pressing  ADJUST button at night makes the caller's face easier to see, but moving subjects may be more difficult to see.

6-10 If optional units are installed

- 1 When a separately-installed sensor detects a malfunction or CALL button is pressed, the alarm sound occurs and the transmit LED (red) flashes.



- 2 Press  OFF button to stop the alarm sound.



1. Even if the chime tone and alert sound volume is set to 0 (OFF), it will sound at a level equivalent to 10 (HIGH).
2. The alarm sound stops after 30 seconds and restoration occurs even if  OFF button is not pressed.

NOTES: If there is a call from the entrance or another inside unit during notification, the system switches to the entrance or other inside unit (communication is prioritized).

7 TECHNICAL PRECAUTIONS

- Operating temperature: 0 °C to 40 °C (+32 °F to +104 °F)
- The video image may distort when the door release is activated. But this is not a unit malfunction.
- Cleaning: Clean the units with a soft cloth dampened with a neutral household cleanser. Do not use any abrasive cleaner or cloth.
- If there is a system malfunction, turn the POWER switch at the monitor station OFF and back ON again. If this does not solve the problem, unplug the DC power supply and contact a qualified technician for service.

8 SPECIFICATIONS

- Power: DC 18 V
- Current consumption: (Max.) 400 mA
- Calling: Chime and image, approx. 45 seconds
- Communication: <HANDS-FREE mode> Hands-free: 60 sec.
<PTT mode> Press-to-talk, release to listen: 60 sec.
- Video monitor: 3-1/2" direct view TFT color LCD
- Scanning lines: 525 lines
- Door release contact: AC/DC 24 V, 0.5 A (N/O dry closure contact L, L) (Minimum contact : 100 mV DC, 0.1 mA) (Aiphone's EL-12S is recommended.)
- Dimensions: 185 (H) x 135 (W) x 27 (D) (mm)
7-5/16 (H) x 5-5/16 (W) x 1-1/16 (D) (inches)
- Weight: Approx. 370 g (0.82 lbs.)

Warranty

English

Aiphone warrants that its products have no material or workmanship defects under normal use conditions for two years after delivery to the end user. Aiphone will perform repair or replacement free of charge if the product is defective and the warranty applies to the defect. Aiphone reserves unto itself the sole right to make the final decision whether there is a defect in materials and/or workmanship and whether or not the product is under warranty. This warranty shall not apply to any Aiphone product which has been subject to misuse, neglect, accident, or to use in violation of instructions furnished, nor extended to units which have been repaired or altered outside of the factory. This warranty does not cover batteries or damage caused by batteries used in connection with the unit. This warranty only includes carry-in repairs. Any repairs must be made at the shop or place designated in writing by Aiphone. Aiphone will not be responsible for any costs incurred during on-site service calls. Aiphone will not provide compensation for any loss or damage incurred by the breakdown or malfunction of its products during use, or for any consequent inconvenience or losses that may result.

The object area of  is the EU.

Garantie

Français

Aiphone garantit que ce produit ne présente pas de défaut matériel ou de fabrication dans des conditions normales d'utilisation pendant les deux années suivant la livraison à l'utilisateur final. Aiphone en effectuera gratuitement la réparation ou le remplacement si le produit est défectueux et que la garantie s'applique pour le défaut. Aiphone se réserve le droit exclusif de décider s'il existe ou non un défaut de matière ou de fabrication et si l'appareil est ou non couvert par la garantie. Cette garantie ne s'applique pas à tout produit Aiphone qui a été l'objet d'une utilisation impropre, de négligence, d'un accident ou qui a été utilisé en dépit des instructions fournies; elle ne couvre pas non plus les appareils qui ont été réparés ou modifiés en dehors de l'usine. Cette garantie ne couvre pas les piles ni les dégâts infligés par les piles utilisées dans l'appareil. Cette garantie comprend uniquement les réparations en atelier. Toutes les réparations doivent être réalisées à l'atelier ou au site désigné par écrit par Aiphone. Aiphone décline toute responsabilité en cas de frais encourus pour les dépannages à domicile. Aiphone n'indemniser pas le client en cas de pertes, de dommages ou de désagréments causés par une panne ou un dysfonctionnement d'un de ses produits.

La zone d'application de  est l'UE.

Garantía

Español

Aiphone garantiza que sus productos no tienen defectos de material ni de mano de obra bajo condiciones de uso normal durante dos años tras su entrega al usuario final. Aiphone realizará la reparación o cambio libre de costo si el producto está defectuoso y la garantía se aplica al defecto. AIPHONE se reserva el derecho de tomar la decisión final de si hay o no defectos de material y/o de mano de obra, y de si el producto está o no cubierto por la garantía. Esta garantía no cubre ningún producto AIPHONE que haya sido mal utilizado, descuidado, accidentado, o empleado violando las instrucciones suministradas; la garantía tampoco se aplica a unidades que hayan sido reparadas o alteradas por personas fuera de la fábrica. Esta garantía no cubre las pilas ni los daños causados por pilas utilizadas asociadas a la unidad. Esta garantía sólo incluye reparaciones acarreadas por el cliente. Todas las reparaciones deben realizarse en el taller o lugar que Aiphone designe por escrito. Aiphone no se responsabilizará de los gastos generados durante llamadas de servicio. Aiphone no indemnizará por ninguna pérdida o daño en que se incurra debido a la avería o falla de sus productos durante su uso, ni por ningún inconveniente o pérdida que se produzca como consecuencia.

El área del objeto  es la EU.

Garantie

Nederlands

Aiphone garandeert dat zijn producten onder normale gebruiksomstandigheden gedurende twee jaar na levering aan de eindgebruiker vrij zijn van materiaal- of fabricagefouten. Aiphone zal het product kosteloos herstellen of vervangen als het defect is en de garantie van toepassing is op het defect. Aiphone behoudt zich het recht voor om als enige definitief te bepalen of er al dan niet sprake is van een materiaal- en/of fabricagefout; en of het product nog onder garantie is. Deze garantie geldt niet voor een Aiphone-product dat is blootgesteld aan verkeerd gebruik, verwaarlozing, een ongeval of verkeerde bediening en evenmin voor toestellen die buiten de fabriek zijn hersteld of gewijzigd. Deze garantie geldt niet voor batterijen of schade veroorzaakt door batterijen die in het toestel zijn gebruikt. Deze garantie geldt uitsluitend voor herstellingen die worden ingeleverd en opgehaald door de klant. Alle herstellingen moeten worden uitgevoerd in de winkel of op de plaats die schriftelijk is aangeduid door Aiphone. Kosten die gepaard gaan met herstellingen ter plaatse kunnen niet worden verhaal op Aiphone. Er kan geen schadeloosstelling van Aiphone worden geëist voor enig verlies of schade als gevolg van een defect of storing tijdens het gebruik van zijn producten, of voor enig ongemak of verlies dat hieruit voortvloeit.

Het toepassingsgebied van  is de EU.

Garanzia

Italiano

La Aiphone garantisce che i suoi prodotti saranno privi di difetti nei materiali o nella lavorazione, in condizioni di utilizzo normali, per un periodo di due anni dalla consegna all'utente finale. La Aiphone eseguirà la riparazione o la sostituzione gratuita del prodotto qualora tale prodotto debba risultare difettoso e la garanzia sia applicabile al difetto rilevato. La Aiphone si riserva il diritto esclusivo di stabilire in via definitiva se sono presenti difetti nei materiali e/o nella lavorazione e se il prodotto è coperto dalla garanzia oppure no. La presente garanzia non è applicabile ad alcun prodotto Aiphone che sia stato sottoposto ad uso improprio, negligenza, incidente, o che sia stato utilizzato in violazione alle istruzioni fornite, né può essere estesa alle unità che sono state riparate o manomesse al di fuori della fabbrica. Questa garanzia non copre le batterie né i danni causati dalle batterie usate in connessione con l'unità. Questa garanzia copre solo le riparazioni del prodotto consegnato presso il punto designato. Le eventuali riparazioni devono essere eseguite presso l'officina o il luogo designato per iscritto dalla Aiphone. La Aiphone non potrà essere ritenuta responsabile di eventuali costi sostenuti in caso di chiamata per l'assistenza sul posto. La Aiphone non offrirà alcun compenso per gli eventuali danni o perdite subiti a causa della rottura o del guasto dei suoi prodotti durante l'uso, o per qualsiasi disagio o perdita conseguente che si dovesse verificare.

L'area oggetto del  è l'UE.

This equipment has been tested and found to comply with the limits for a Class B digital device, pursuant to Part 15 of the FCC Rules. These limits are designed to provide reasonable protection against harmful interference in a residential installation. This equipment generates, uses, and can radiate radio frequency energy, and if not installed and used in accordance with the instructions, may cause harmful interference to radio communications. However, there is no guarantee that interference will not occur in a particular installation. If this equipment does cause harmful interference to radio or television reception, which can be determined by turning the equipment off and on, the user is encouraged to try to correct the interference by one or more of the following measures: · Reorient or relocate the receiving antenna · Connect the equipment into an outlet on a circuit different from that to which the receiver is connected. Increase the separation between the equipment and receiver. · Consult the dealer or an experienced radio/TV technician for help.



Providing Peace of Mind

<http://www.aiphone.com/>

AIPHONE CO., LTD., NAGOYA, JAPAN
AIPHONE CORPORATION, BELLEVUE, WA, USA
AIPHONE S.A.S., LISSES-EVRY, FRANCE

Printed in Thailand