

CLIPSAL® speakers by **KRIX**®



atmospherix®

concealed audio loudspeaker
5600K03

Installation Instructions

atmospherix - specifications

5600K03-WE atmospherix speaker, in-ceiling round single, white

Frequency Range:	45Hz - 20kHz in room response
Power Handling:	Maximum 100 Watts RMS amplifier power
Sensitivity:	90dB for 2.83 volts at 1 metre
Impedance:	Nominally 6 ohms
Dimensions:	280mm (11") high x 190mm (7-1/2) deep
Mounting Diameter	247mm (9-3/4")
Weight:	2.5kg (5.5 lb)

Step 1

Choose the best location for your in-ceiling loudspeakers and check for any obstructions, such as electrical wiring, stud work or air conditioning ducts before commencing the installation. Also check that there is enough ceiling space to accommodate the speaker enclosure.

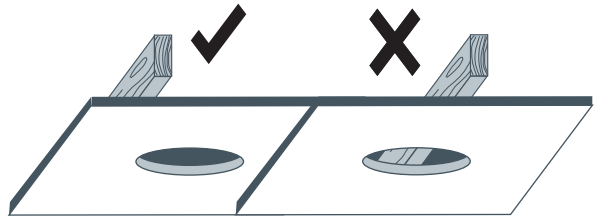

Specifications and instructions are supplied for general information only and may change without notice. There are no user serviceable parts. If you require further assistance please contact Clipsal Technical Support. Designed and engineered by Krix Loudspeakers Pty Ltd. Manufactured in China.

Step 2

Use the cardboard cut out template packed in the carton to draw the required cut-out circle onto the ceiling or wall.

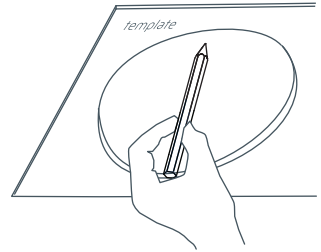

CAUTION

Use care when cutting into walls or ceilings. You could come in contact with dangerous voltages from installed wiring.

Step 3

Drill a small hole in the centre of the marked cut-out and then using a fine-tooth gyprock saw, cut toward the line and cut out the circle. Remove the waste piece. Insert the speaker to make sure the hole is the right size. Enlarge the hole if required.

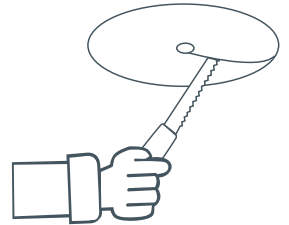

Step 4

Pull the speaker cable through the opening and strip approximately 10mm (0.39") of the insulation to expose the copper wire. Insert the bare wires into the speaker connections. Observe the correct polarity; make sure the corresponding red (+) and black (-) amplifier terminals are connected to the corresponding speaker terminals.

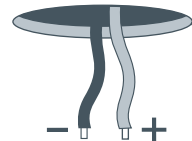

Step 5

Remove the speaker grille using the mounting clamps located around the edge of the enclosure. Swing the mounting clamps out so that they are at a 90 degree angle from the enclosure. Gently push upward on the clamps until the grille lifts away. Use care to avoid bending the grille.

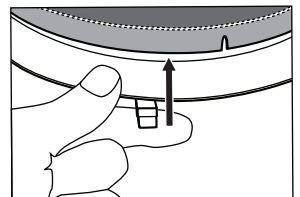

Step 6

To insert the wires in the binding posts on the speaker, press and hold the binding post and insert the bare wire. Then release the binding post. The red binding post is the positive (+) terminal and the black binding post is the negative (-) terminal.

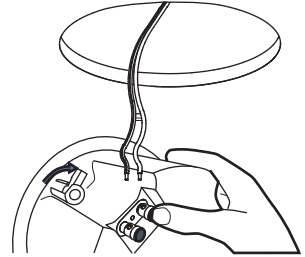

Step 7

Swing the mounting clips inward toward the speaker enclosure to allow the speaker to be easily inserted in the ceiling cut out.

When the speaker is located in the ceiling or wall, use a Phillips head screwdriver to tighten the mounting screws. Do not over tighten screws, as this might strip the clamp or crush the gyprock.

As the screws are tightened, the mounting clamps automatically swing out over the gyprock and clamp the speaker in place.

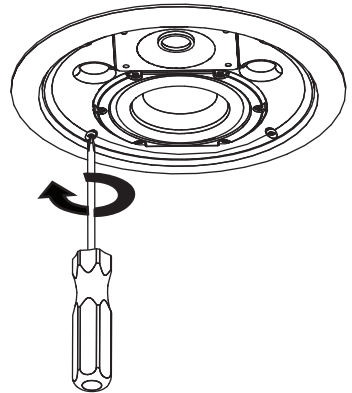

Step 8

Concealed audio products may feature a pivoting tweeter to direct high frequencies in the preferred direction. To aim the tweeter, gently press on the round outer edge of the tweeter frame to tilt the tweeter to the desired position. Do not touch the tweeter dome with your fingers or any tools.

If painting the grille and speaker frame is not required, gently fit the metal grille to the front of the speaker housing.

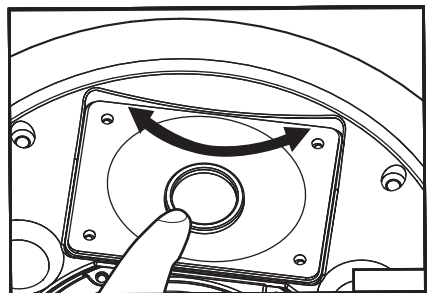

If the grille and speaker frame require painting, be sure to mask off the speaker drivers. When painting the grille, it might be necessary to thin down the paint to avoid blocking the holes in the grille. After the paint is completely dry, fit the grille to the front of the speaker.

If you have installation questions, contact Clipsal Technical Support at one of the numbers below. For warranty questions, refer to the warranty form that is provided with this product.

Clipsal Technical Support Contact Numbers	
Australia	1300 722 247 (CIS Technical Support Hotline)
New Zealand	0800 888 219 (CIS Technical Support Hotline)
Northern Asia	+852 2484 4157 (Clipsal Hong Kong)
South Africa	011 314 5200 (C-Bus Technical Support)
Southern Asia	+603 7665 3555 Ext. 236 or 242 (CIS Malaysia)
United Kingdom	0870 608 8 608 (Schneider Electric Support)

Clipsal CIS Technical Support email: cis.support@clipsal.com.au

Clipsal Australia Pty Ltd

A member of Schneider Electric

Contact us: [clipsal.com/feedback](https://www.clipsal.com/feedback)

National Customer Care Enquiries:

Tel 1300 2025 25

Fax 1300 2025 56

clipsal.com

Clipsal Australia Pty Ltd reserves the right to change specifications, modify designs and discontinue items without incurring obligation and whilst every effort is made to ensure that descriptions, specifications and other information in this catalogue are correct, no warranty is given in respect thereof and the company shall not be liable for any error therein.

© Clipsal Australia Pty Ltd. The identified trademarks and copyrights are the property of Clipsal Australia Pty Ltd unless otherwise noted.