

INSTALLATION NOTES

NESS
lux



NESS LUX WIRED PIR WITH NIGHTLIGHT

- Quad element pyro sensor
- 15m x 15m wide angle coverage
- Look down 'Creep Zone'
- Selectable Standard and Pet Aware modes
- Adjustable sensor mask for No Creep and Pet modes
- Supports Home Automation with fast response output
- White LED motion activated night-light
- Adjustable Digital Pulse Count
- Adjustable Digital Range
- High R.F. and E.S.D. immunity
- High white light immunity
- High quality patented Fresnel lens
- Capsule design with sealed electronics
- Front cover tamper protection
- Totally silent solid state relay with high immunity to magnetic fields
- Optional mounting bracket available



SELECTABLE PET AWARE

INTRODUCTION

Ness LUX HW wired PIR is a unique high performance motion detector with a white LED night-light.

LUX HW features include 15m x 15m detection coverage, look-down creep zone with adjustable masking, selectable standard or Pet Aware modes, high RF immunity, white light immunity, adjustable digital range, adjustable digital pulse count.

LUX HW also has built-in support for home automation functions with a fast response motion sensor output designed to feed to automation systems.

LUX HW has a wide power input range of 10~15VDC designed to operate on all Ness alarm control panels and automation systems.

The “capsule” design protects sensitive electronic components and provides easy access to the terminals and dipswitches.

For safety and convenience, LUX HW’s night-light function provides a motion-activated cone of light to help you find your way at night. The night-light operates for 25 seconds when activated and will remain lit as long as it detects motion, while the built-in ambient light sensor helps save power by enabling the night-light only in the dark

DETECTION COVERAGE

At the recommended mounting height of 2.1m~2.3m, LUX detector coverage is up to 15m (HIGH range setting) or 12m (LOW range setting).

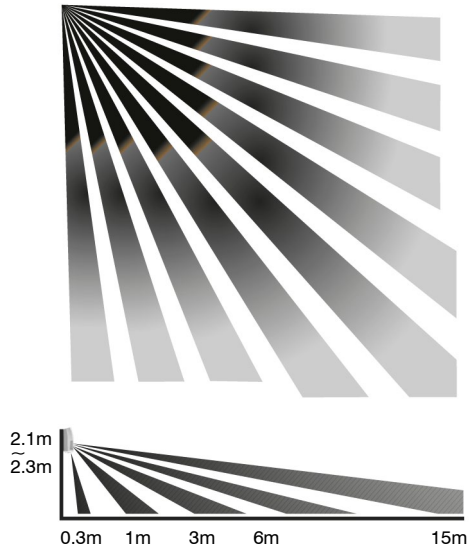

Coverage pattern shown is with the sensor mask in position 1 (no masking).

PET AWARE MODE

In Pet Aware mode (see Settings) the lower detection zones are masked by the sensor mask while the upper detection zones are optimised for detecting humans.

If using the optional Quantum Swivel Bracket, ensure that the detector is not tilted downwards to prevent the upper detection zones from intersecting the floor.

Note that in Pet Mode detection sensitivity will be reduced closer to the floor. You may need to use the optional Quantum swivel bracket to adjust the coverage for a balance of detection coverage for human and pets.

⚠ Installing the detector lower than 2.1metres may result in false detection of animals.

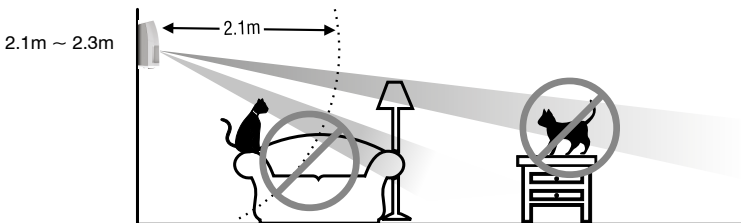

Install at least 2.1m away from furniture to prevent detection of climbing pets.

COMPONENTS

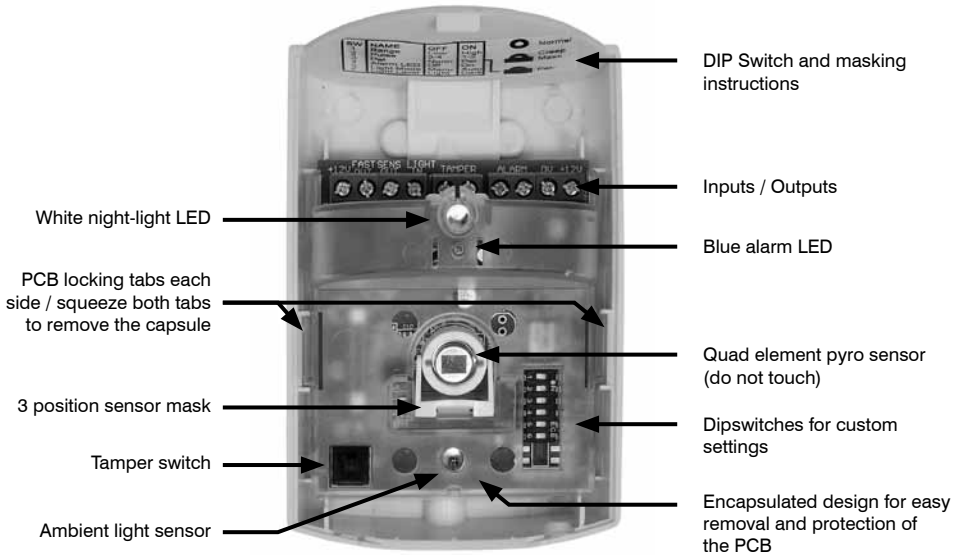
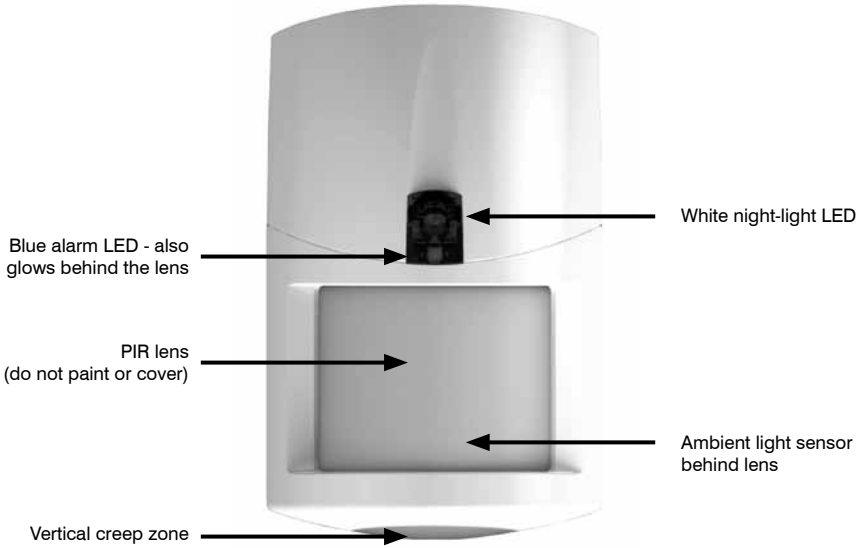

MOUNTING LOCATION

The Ness LUX hardwired PIR is designed for indoor use only and can be installed in wall or corner mount locations.

LUX is designed to be wall or corner mounted at the optimal height of 2.1m~2.3m.

The optional Ness Quantum Bracket allows LUX to be ceiling mounting with a wide range of tilt and swivel adjustment.

Always ensure the detector has a clear line of sight in the area to be protected as infra-red energy does not pass through solid objects, (including glass).

Mount the detector in a location where an intruder is most likely to walk across the coverage pattern. Corner mounting usually gives the best detection coverage.

As with all PIR detectors, it is advisable to choose mounting positions which avoid direct sunlight, heating or cooling sources and avoid areas of high humidity which may cause condensation on the lens.

MOUNTING HEIGHT

The Ness LUX hardwired PIR is designed for indoor use and can be wall or corner mounted at the recommended height of 2.1m~2.3m.

LUX can be mounting at higher or lower heights at the installer's discretion when using the optional Quantum Swivel Bracket which provides tilt and swivel adjustment to cater for the shape or size of the room.

If LUX is direct mounted without a bracket, the installer's choice of mounting height and position will entirely determine the coverage.

NIGHT LIGHT OPERATION

For safety and convenience, the night-light operates for 25 seconds when activated and will remain lit as long as it detects motion, while the built-in ambient light sensor helps save power by enabling the night-light only in the dark.

The night-light's operation is controlled by switch 5 (auto/manual) and switch 6 (light level).

The night-light also operates for one hour after power-up regardless of switch settings to provide an extra bright light source along with the blue LED for walk-testing.

INSTALLATION

- 1 Remove the lock screw at the bottom of the LUX assembly (if fitted) then using a small flat bladed screwdriver release the two front cover tabs and remove the front cover, bottom first.
- 2 Release the PIR capsule from the back housing by squeezing the two locking tabs on either side of the capsule. Remove the capsule to keep it safe while you install the back housing.
- 3 Drill out a cable entry hole at the top of the LUX back housing. The cable entry hole should be small enough for a tight cable fit to prevent insects entering the sensor.

The housing has cable channel to allow mounting on hard surfaces with cable entry top or bottom.

- 4 Install the LUX back housing to the wall using four screws appropriate for the surface.

At this stage any oversized cable entry or mounting holes should be sealed with silicone to prevent the entry of dirt and insects.
- 5 Insert the PIR capsule into the back housing and push gently until the two locking tabs click into place.
- 6 Connect your power, alarm and other wiring as required.
- 7 Set the dipswitches as required.
- 8 Replace the front cover and walk test the PIR. Fit the bottom locking screw once walk testing is complete.

NOTE. Ensure that LUX HW is not installed in the same area as a strong source of infrared energy (such as an IR CCTV camera) as this may interfere with the operation of the light sensor.

SENSOR MASK

LUX hardwired PIR has a unique sensor mask which allows the PIR to operate in Normal, No Creep and Pet Aware modes.

The sensor mask has a hinged action and flips up from the bottom as per the diagrams below.

Please ensure that the sensor mask is in the correct position for the required mode. ie, for Pet Aware mode select dipswitch 3 on and move the sensor mask to position 3.



3 position Sensor Mask.
Lift up to adjust.



Position 1
NORMAL DETECTION
MODE (default)



Position 2
NO CREEP ZONE MODE









Position 3
PET AWARE MODE

SETTINGS

Ness LUX custom settings are set by dipswitches 1-6. The dipswitches are easily accessible on the sensor capsule.

Use a small screwdriver or pen tip to set the switches.

	SW	NAME	OFF	ON
	1	Range	Low	High
	2	Pulse	3-4	1-2
	3	Pet	Normal	Pet
	4	Alarm LED	Off	On
	5	Light Mode	Manual	Auto
	6	Light level	Light	Dark

SWITCH 1 - RANGE

Sets the detector's sensitivity. Low range is recommended for coverage of areas under than 12m.

Low Low range, 12m max coverage.
(Default)

High High range, 15m max coverage.

SWITCH 2 - PULSE

Sets the detector's pulse count.

3-4 3-4 Pulses or walk steps should cause an alarm. (Default)

1-2 1-2 Pulses or walk steps should cause an alarm.

SWITCH 3 - PET

Enables Pet Aware mode which tunes the response and sensitivity for pet immunity.

OFF Normal mode. Set the sensor mask in position 1 or 2. (Default)

ON Pet Aware mode.

The sensor mask must be in position 3 when Pet Aware mode on enabled.

SWITCH 4 - LED

Enables the blue Alarm LED.

OFF The Alarm LED is disabled.

ON The Alarm LED is enabled. (Default)

SWITCH 5 - LIGHT MODE

Sets the operation of the white night-light LED.

Manual Manual control of the night-light using the Light In terminal.

Auto Automatic operation of the night-light (Default) means the night-light will activate when movement is detected in darkness. In this mode, manual control is also allowed using the Light In terminal.

In Auto mode and for one hour after power-up, the night-light will operate along with the blue LED to provide an extra bright light source for walk-testing.

SWITCH 6 - LIGHT LEVEL

Sets the light level at which LUX's ambient light sensor will enable the night-light.

Light The night-light will operate when the ambient lighting is semi-dark. (Default)

Dark The night-light will operate only when the ambient lighting is very low or near total darkness.

TERMINALS

+12V / 0V

10~15VDC power input terminals

ALARM

Two terminals for the alarm output. Normally closed alarm contacts are open circuit in alarm condition.

TAMPER

Two terminals for the mechanical tamper switch operated by the front cover. Normally closed contacts are open circuit when the front cover is removed.

LIGHT IN

Provides external control of the night-light. Pull low to 0V (negative) to activate the night-light at any time. This terminal can be driven by an output from a control panel such as Ness D8x/D16x, Smart-Living or M1.

SENS OUT

Indicates the status of the light sensor. The output is on when the night-light's programmed darkness threshold is reached and will activate even if the night-light is disabled.

This is an open collector output and pulls low to 0V (negative) when active. An external pull-up resistor is required to drive devices such as relays. Dark threshold is controlled by the Light Level dipswitch.

This output may be connected in parallel with Sensor Out terminals on other LUX PIRs if required.

The output is OFF when the room is illuminated. Eg Daytime, or light ON

The output is ON when the room is dark.

FAST OUT

This output indicates movement in the protected area, regardless of the pulse count setting.

This is useful for home automation and light control where a normal security PIR may react too slowly.

This is an open collector output and pulls low to 0V (negative) when active. An external pull-up resistor is required to drive devices such as relays.

The output may be connected in parallel with the Fast Alarm terminals on other LUX PIRs if required.

Activation speed is independent of the Pulse dip-switch setting, ie, pulse count is always one for fast response.

The output is OFF when there is no movement in the protected area.

The output is ON (pulls to 0V) when movement is detected in the protected area.

+12V

This terminal is directly connected to the +12V power input terminal and can be used to connect pull-up resistors for the Sensor Out and Fast Alarm Out terminals if required.

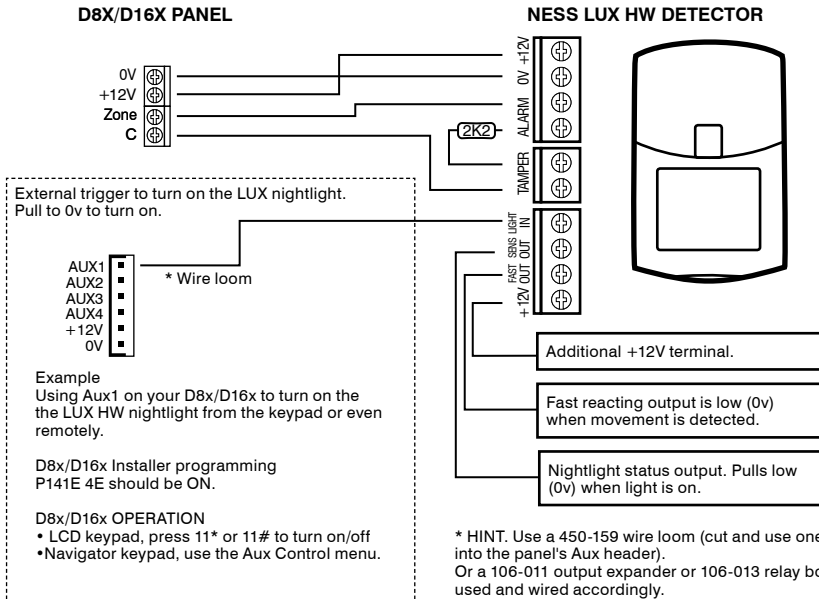

SPECIFICATIONS

Dimensions	112(h) x 72(w) x 48(d) mm
Mounting height	2.1m ~ 2.3m
Coverage	Up to 15m x 15m @ 90°
Detection zones	20 quad element zones
Pulse count	Selectable 1-2 or 3-4
Range	Selectable High/Low. 15m max./12m max.
Sensor	Quad element pyroelectric
Alarm indication	Blue alarm LED
Relay output	Solid state relay, normally closed contacts, 100mA max.
Tamper output	Normally closed switch
FAST output & SENS output	Open collector (pulls to 0V/Neg)
Light In input	Pull low to 0V/Neg to activate
Night-Light	White LED with adjustable threshold, Dark/Dim Light
Pet Immunity (Pet Aware mode)	Single pet up to 18kg or multiple pets up to 10kg total
Alarm period	2 seconds
Warm up period	30 seconds
Operating voltage	10 ~ 15V DC
Current draw	10mA
Operating Temperature	0° ~ 50°C
Compatibility	All hardwired control panels



OPTIONAL ACCESSORIES

QUANTUM SWIVEL BRACKET can be used to provide wall or ceiling mounting with a wide range of vertical and horizontal adjustment.

Part No. 100-243



CORPORATION

www.nesscorporation.com

National Customer Service Centre
Ph: 1300 551 991



DOCUMENT PART NUMBER 890-467
Rev1.1 Oct 2015

For products:
106-173 Ness LUX Hardwired PIR

© 2015 Ness Corporation Pty Ltd ABN 28 069 984 372
Specifications may change without notice.

